

# ELLIIT — Strategic Research for Society and Industry



Excellence Center at Linköping – Lund  
in Information Technology

**Digitalisation, IT and mobile communications technology are transforming our lives and constitute a backbone in Swedish industry.**

**ELLIIT is one of two strategic research environments within this field created by the Swedish government in 2010, and has four partners: Linköping University, Lund University, Blekinge Institute of Technology and Halmstad University, with Linköping University as coordinator.**

**This book uses 17 case studies to illustrate how ELLIIT has generated new ideas within basic research, and how it has developed and exploited these ideas, making an impact on Swedish society and industry.**

Contributors: **Martin Hell, Bo Bernhardsson, Anders Robertsson, Fredrik Tufvesson, Michael Felsberg, Björn Landfeldt, Anton Cervin, Tom Ziemke, Görel Hedin, Fredrik Gustafsson, Atila Alvandpour, Henrik Sjöland, Jörn Janneck, Nauman bin Ali, Anders Ynnerman**

Contact: **Erik G Larsson, Director, erik.g.larsson@liu.se**  
**Fredrik Tufvesson, Co-Director, fredrik.tufvesson@eit.lth.se**

More information: [www.elliit.se](http://www.elliit.se)



Photos: Linköping university, Lund university, Instagram, H2020 5G-SMART, Ericsson, Fredrik Gustafsson, Porsche, Björn Landfeldt, Martin Stenmarck

iStock photos: BlackJack3D, Christian Horz, angkhan, metamorworks, steverts, SvProduction, ipopba, miodrag ignjatovic, NicoEINinjo

Text: Monica Svenselius, translated by George Farrants

Design & Layout: Jessica Nilsson

Print: Tryckeriet i E-huset, Lund, 2021

# ELLIIT — Strategic Research for Society and Industry

- Studies of automatic control contribute to human immunology research 4-5
- From theory to leading technology for 5G 6-7
- Chip design for 6G and life 8-9
- High-frequency technology lifts Ericsson's 5G initiative 10-11
- 5G comes to vehicle communication 12-13
- Leaving avoidance manoeuvres to the car reduces the risk of an accident 14-15
- Robots becoming part of everyday life 16-17
- From a degree project to 9000 citations and a company 18-19
- Finding your way with three-in-one 20-21
- Visualising the invisible 22-23
- Keeping track of open-source code 24-25
- Computer tools build bridges between research disciplines 26-27
- The art of simulating and optimising cyber-physical systems 28-29
- Smart chip design for streaming data 30-31
- Dialogue improves software development 32-33
- Smart automatic control helps protons hit the target 34-35
- Degree projects bring smart agriculture advances 36-37



## Studies of automatic control contribute to human immunology research

**With the spread of covid-19 around the world, it has become more obvious than ever before that the immune system differs between individuals. A major study of blood from 1000 people in France has given some insight into the riddle, using mathematical modelling and theories of automatic control.**

Bo Bernhardsson, ELLIIT professor in the Department of Automatic Control at Lund University, realised at an early stage the methods used in automatic control can be used in many other contexts. His doctoral student, Jacob Bergstedt, took his expertise in mathematics and automatic control to the Institut Pasteur in Paris to work on modelling the human immune system, partially financed by ELLIIT.

In the years 2014-2018, scientists worked on the Milieu Intérieur project, using unique data from 1000 healthy people in France. They wanted to use refined statistical analysis to try to understand what it is that makes the

immune systems of different people function so differently. Their goal was to investigate the links between the immune system, heredity and the environment, i.e., how both our genes and our surroundings and lifestyle choices influence the immune system.

They have analysed the information using data from flow cytometry (a technique in which one type of cell is sorted out from the total cell population), demographic and clinical variables, and genotype analysis. The large amount of data makes it possible to find as yet unrevealed correlations.

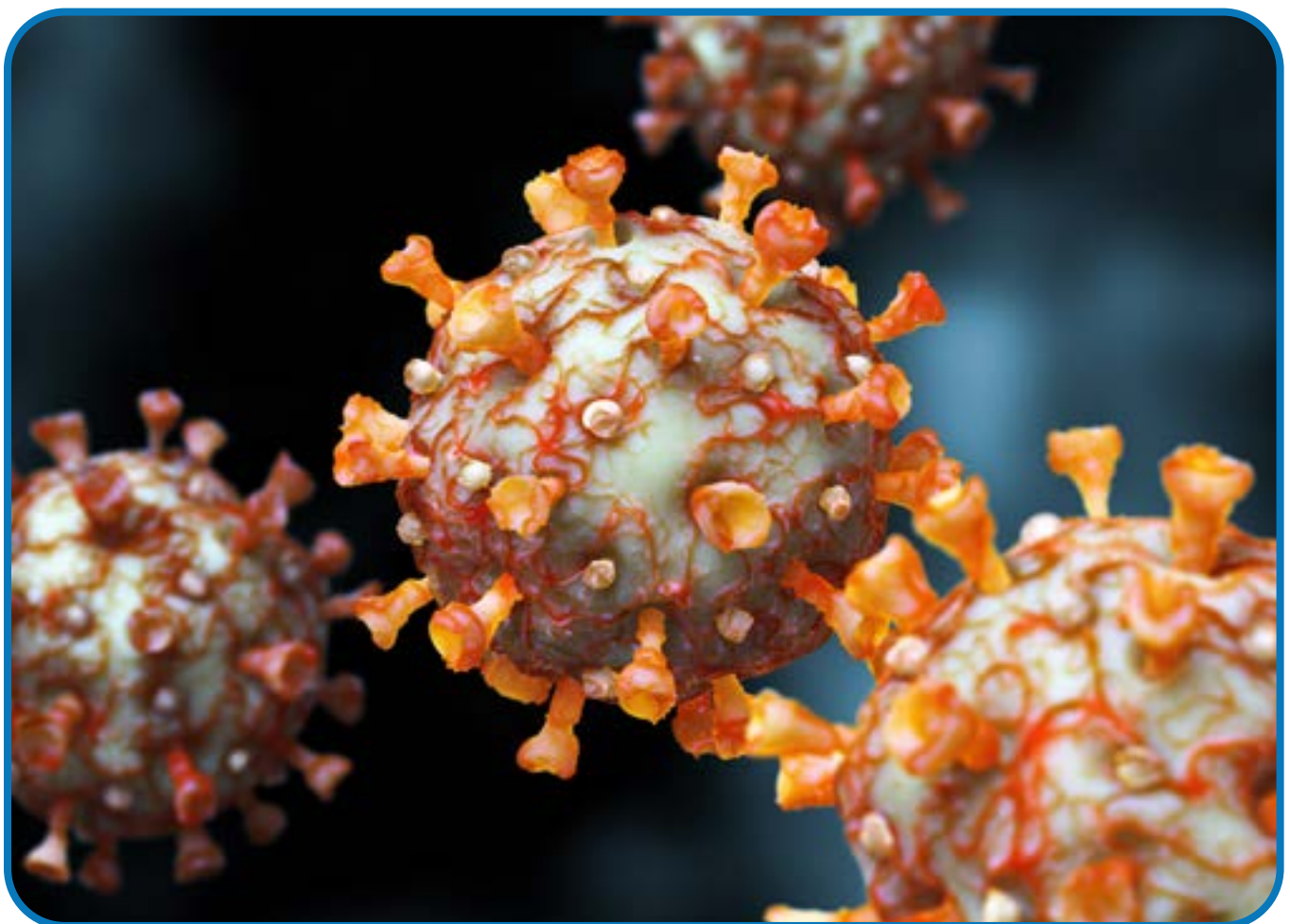

“Several billion hypotheses were examined during the project, and it needed accurate and efficient modelling and statistical methods to come to the right conclusions that were statistically proven and not the result of random effects”, says Bo Bernhardsson.

This is where Jacob Bergstedt’s expertise was in demand. Together with medical researchers at the Institut Pasteur, he was able to draw some clear conclusions: they identified 15 new mutations in the human genome that influence the immune system. They have shown that women produce more T cells than men, which may explain why women contract influenza and the common cold less frequently, while instead being more susceptible to autoimmune diseases. They have also shown that certain environmental factors have the largest effects on the immune system. Tobacco smoking, for example, impairs the immune system, and older people have less effective immune systems.

“A lot of research remains to be done into the immune system, but we hope that our research will in the long term lead to individualised medication and better medical care”, says Bo Bernhardsson.

The research results from the Institut Pasteur have been published in many prestigious scientific journals such as Nature Immunology, Science Translational Medicine, and Proceedings of the National Academy of Sciences (PNAS). The results have also aroused interest in the Swedish media, such as, for example, the radio program Vetenskapsradion (Därför blir människor olika sjuka) and the newspaper Sydsvenska Dagbladet (Män är mer förkylda än kvinnor – nu vet vi kanske varför)

One consequence of this is that ELLIIT researchers have been involved in predicting the spread of the coronavirus, and this work continues today.

“We have benefited greatly during the pandemic from our work with the French scientists. A group within ELLIIT that includes Fredrik Gustafsson, professor in sensor informatics at Linköping University and Kristian Soltesz, docent in automatic control at Lund University is helping the Swedish regional administrations predict the spread of the pandemic. Collaboration within ELLIIT has been crucial”, says Bo Bernhardsson.

Jacob Bergstedt’s thesis, Statistic Modeling and Learning of the Environmental and Genetic Drivers of Variation in Human Immunity, was presented at Lund University in 2018. Jacob Bergstedt continued after presenting the thesis as a postdoc at the Institut Pasteur, and is now at Karolinska Institutet.



Bo Bernhardsson, professor in automatic control, Department of Automatic Control, Lund University.  
Kristian Soltesz, senior lecturer and docent in automatic control, Lund University.  
Magnus Fontes, professor of mathematics, currently employed by the Roches research department in Paris.



## From theory to leading technology for 5G

**The “Massive MIMO” communication technology has become a cornerstone in the construction of the 5G network. Research within ELLIIT has been closely involved along the complete journey – from a new and interesting theoretical concept, through demonstrations that it works in practice, to industrialisation and construction.**

The ideas behind this communication technology originated with Tom Marzetta at Bell Labs, working at New Jersey in the US, in 2009. ELLIIT researchers were early to recognise its potential, and started the first projects as early as 2010, without at that time realising that the technology would form the foundation of the fifth generation of wireless network ten years in the future.

Scientists at Linköping University, under the leadership of Professor Erik G Larsson in the Department of Electrical Engineering, developed the theoretical basis, while scientists at Lund University, under the leadership of Professors Fredrik Tufvesson and Ove Edfors in the Department of Electrical and Information Technology, started to study how the technology could be converted to reality.

“This is a field within ELLIIT that has seen long and close collaboration between researchers in Linköping and Lund. Several joint projects have been financed by the Swedish Research Council and the Swedish Foundation for Strategic Research, and most recently also by the Mammoet EU programme”, says Fredrik Tufvesson.

The original theories from Tom Marzetta used an infinite number of antennas. This means that the first project for the researchers in Lund was to find out how many antennas would be involved in practice. “It turned out that in this case an infinite number was 128. We used recorded channel data to verify the theoretical algorithms, and we were the first in the world to demonstrate that it worked in practice and in real time”, says Fredrik Tufvesson.



Research transformed Massive MIMO from a visionary communication theory to a technology that constitutes the foundation of today's 5G network. Photo: H2020 5G-SMART.



The researchers could also demonstrate how the hardware functioned, and confirm that it functioned even in noisy city traffic.

Within the framework of ELLIIT, the researchers in Lund have also developed a high-performance chip.

“What’s interesting and unique here is that ELLIIT has been involved along the complete journey, from a visionary communication theory to working antennas and a technology that constitutes the foundation of today’s 5G network”, says Fredrik Tufvesson.

However, the work has involved other researchers than just those in Lund and Linköping. Scientists have collaborated with both academic and industrial partners, in Sweden and abroad.

“We contacted the inventor at an early stage so that we could understand the potential in depth. In 2009, the theory was considered to be far too complicated to ever work in practice”, he says.

The collaboration with National Instruments was important in getting rapid access to a test rig, and investigating in collaboration with Bristol University whether the antenna technology could function in real time.

“The EU project Mammoet was also key to bringing our research closer to industrial application. The close collaboration with Ericsson and Sony meant not only that Sweden achieved a leading position in the field, but also that the Massive MIMO technology became a fundamental pillar of the 5G standard. And this the case not only in Europe but also other parts of the world”, says Fredrik Tufvesson.

The next phase is to for the researchers in Lund and Linköping to develop the technology towards 5G+ and 6G. The joint EU project Reindeer was recently started to take the technology to the next level.

“MIMO” is an acronym for “Multiple-Input Multiple-Output”.

Hundreds of small antennas, each of which may have a power of 10 mW, are connected. All the antennas send signals with carefully determined delays. The delays are chosen so that the copies of a signal arrive at the intended receivers at exactly the same instant, but at slightly different times at all other receivers. This gives a strong signal at the intended receiver and only a slight disturbance at all the others. One hundred antennas each of 10 mW gives a power of 1 W, which is distributed among the users. This is considerably less than the power used by antennas in the 4G network. The low power is enough, since each signal is given in a specified direction. Massive MIMO thus provides a combination of low output power, high energy efficiency and superior capacity, since many receivers can receive signals at the same time.

Many scientists have been involved in the development during the past ten years, of which the core has been:

Fredrik Tufvesson, professor of radio systems

Ove Edfors, professor of radio systems

Liang Liu, senior lecturer in digital electronic design  
all of whom work at the Department of Electrical and Information Technology, Lund University.

Erik G Larsson, professor in communication systems

Emil Björnson, associate professor in communication systems both working in the Department of Electrical Engineering, Linköping University.

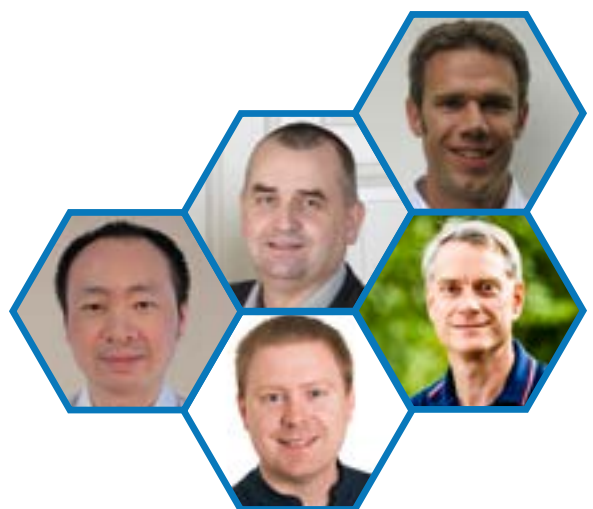

## Chip design for 6G and life

**Research under the auspices of the ELLIIT collaboration into circuit design for 5G and 6G networks is now leading the world. Linköping University is home to a Swedish centre of expertise for both energy-efficient and lightning-fast integrated circuits and less rapid circuits with extremely low energy consumption.**

“We are in the vanguard of research in IC design, which means that our students and doctoral students have knowledge that is equally advanced. Together with our collaboration partners at Lund University, we provide expertise to Ericsson and other industrial actors in the field”, says Atila Alvandpour, professor in the Integrated Circuits and Systems Division, Linköping University.

Research groups in Linköping and Lund started work in the field at an early stage when the first rules for chip design started to appear in the scientific literature towards the end of the 1970s. At the time, 20,000 transistors could be manufactured on a single chip, and the first textbook in IC design was published by American researchers Lynn Conway and Carver Mead in 1979. The first courses in chip design in the Nordic region, and probably also in Europe, were held in the spring of 1981 at Linköping University, and research here has led the world ever since.

The ELLIIT collaboration in recent years between groups in Lund and Linköping has been important for the development of, for example, Ericsson’s new base stations for the 5G network and the development of high data rate and energy-efficient electronic circuits to convert analogue to digital signals and vice versa. Such converters are necessary for the traffic between mobile phones and base stations. High data rate and energy-efficient radio circuits are also critical requirements for 5G and 6G technology.

“The new antenna technology for 5G and 6G known as “massive MIMO” uses arrays of radio links that are connected to individual small antennas with a very high data rate, which leads to high power consumption. Since there are so many circuits, each tiny increase in energy efficiency has a profound effect on the overall result. Today, we are in the front line when it comes to high-speed, low-power circuits for 5G and 6G”, says Atila Alvandpour.

Another important line in circuit design research is prominent at Linköping University – circuits with extremely low power consumption, some of which can even harvest energy, for use in medical applications.

“These circuits are not particularly fast, but they don’t have to be. Here the key challenge is to arrive at extremely low power consumption. We are working in collaboration with medical researchers at Karolinska Institutet, and other sites. We have developed circuits for pacemakers that harvest energy from heartbeats, and in the most recent project we have developed circuits for sensors that monitor the cells in the pancreas that produce insulin. Here, we can contribute to more effective medicines to treat diabetes”, says Atila Alvandpour.

Atila Alvandpour and his group at LiU are also coordinators for the centre of expertise in integrated circuits and systems within the Swedish strategic innovation programme Electronic Components and Systems financed by Vinnova, the Swedish Energy Agency and Formas. Within this Swedish centre of expertise, new collaborations are continuously being established between small and large Swedish companies and researchers at Swedish universities and research institutes.



The group have developed circuits for pacemakers that harvest energy from heartbeats.



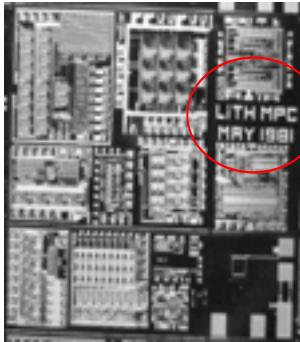

First ever fabricated student chip project in 1981, Linköping.

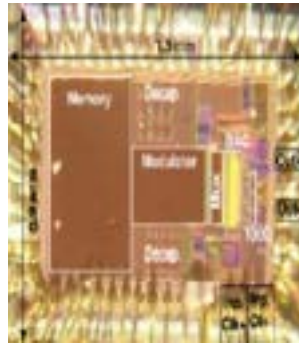

Fasted reported Digital-to-Analog converter for its class. An 11 GS/s 1.1 GHz Bandwidth Interleaved  $\Sigma\Delta$  DAC for 60-GHz radio in 65 nm CMOS.

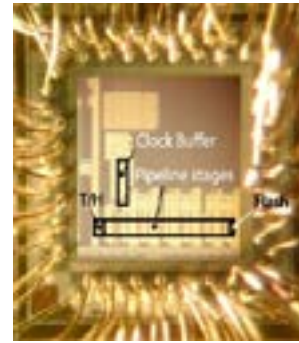

Fastest reported pipeline Analog-to-Digital converter for wideband communications. A 2.4 GS/s, 8 bit, Single-channel Pipeline ADC in 65 nm CMOS.

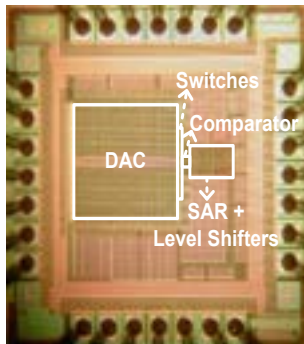

First reported ADC with nano-Watt power consumption. A 53-nW 9.12-ENOB 1-kS/s SAR ADC for Medical Implant Devices.

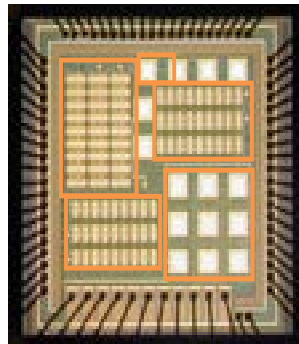

First reported microwatt level piezoelectric energy harvesting IC for self-powered leadless pacemakers, harvesting heart beats mechanical energy to electrical energy.

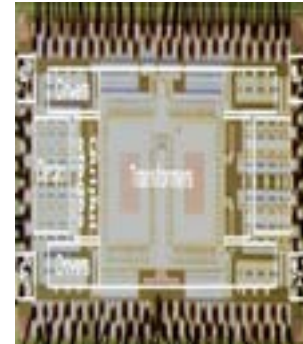

Pioneering work and solutions for wideband radio transmitter. Example: A wideband (1.6 GHz) +30dBm Class-D Outphasing RF Power Amplifier in 65 nm CMOS for WCDMA and LTE.

Atila Alvandpour, professor, Christer Svensson, professor emeritus, and Ted Johansson, adjunct professor, Division of integrated Circuits and Systems, Department of Electrical Engineering, Linköping University. Six doctoral students, four of whom have defended their dissertations during their work.



# High-frequency technology lifts Ericsson's 5G initiative

**Advances in CMOS millimetre wave circuit design were driven by a shortage of frequencies and a desire to challenge the limits of the possible. Results from ELLIIT research in Lund and Linköping have made vital contributions to Ericsson's new base stations for 5G**

As early as 2003, the research group in Lund started its first project as part of a long-term plan to build beam-forming transmitters and receivers using CMOS technology for millimetre waves. Attempts were under way in Linköping to develop circuits using CMOS technology that could convert digital to analogue signals, and vice versa, at the significantly higher bandwidths that were involved.

“The research community was distinctly sceptical whether this was possible, since the transistors available at the time were too large and thus too slow”, remembers Henrik Sjöland, professor in integrated electronic systems, at the Department of Electrical and Information Technology, Lund University, who also works at Ericsson in Lund.

The ambition at this early stage to use higher frequencies came from, among other things, experiences with 3G frequency congestion with such equipment as TV transmitters, GPS, microwave ovens and Wi-Fi. Millimetre waves have frequencies between 24 GHz and 300 GHz, a very large frequency range that offers both high speed and plenty of bandwidth for future mobile phones, the internet of things, and streamed media.

It took about ten years of research before the group could present an award-winning architecture for beam-forming, where they could also demonstrate high-performance circuits in CMOS technology. Since higher frequencies means more attenuation and thereby shorter communication range, the beams from many small antennas must be combined and directed more precisely towards the target. Thus, an important part of the architecture are circuits designed in-house that make possible accurate individual phase control of the antenna signals.

“We built up imposing knowledge in the design of CMOS circuits for millimetre waves”, says Henrik Sjöland.

While the group in Lund worked with millimetre wave transmitters and receivers, researchers in Linköping investigated analogue to digital converters, and vice versa, for high bandwidths. Under the leadership of Professor Atila Alvandpour, the group presented novel architectures in the field, and demonstrated high-performance circuits in CMOS technology.

“By this time, it had become obvious that the rapid wireless transfer of the future would depend on several things: the development of CMOS technology, and the combination of millimetre wave transmitters and receivers with high-bandwidth converters. The collaboration between our research groups became more intense within ELLIIT”, says Henrik Sjöland.

These technologies have been decisive in the development of chips for Ericsson's 5G base stations, a development led from Lund. Many doctoral students who have presented their theses in Lund or Linköping are now working at Ericsson on the development of chips and systems for 5G, and Ericsson currently has two industry-based doctoral students in Henrik Sjöland's group.

“I cannot underline enough the significance of Ericsson's advantage in 5G radio technology. A central part in the development of base stations for 5G is the recent design of circuits in CMOS technology, as pursued by the ELLIIT research initiative. The transfer of technology and expertise within this field is a key to success, now and in the future”, says Henrik Sjöland.

A new joint ELLIIT project started in 2021 with the objective to build circuits for 100 GHz or more, to be used in 6G systems and radar.

“For CMOS technology, it may be that the limit will soon be reached for the speed of circuits we can design, but we will try to squeeze the last little bit of performance out”, says Henrik Sjöland.

**CMOS – Complementary metal oxide semiconductor:** a semiconductor built principally from silicon using a method in which complementary transistors of n-type and p-type (in which negative or positive charged particles conduct electricity) are combined to form logic gates. The technology is required to achieve the density used in today's integrated circuits, in which billions of transistors can be gathered on one chip. The first functional MOS transistor was revealed in 1959.

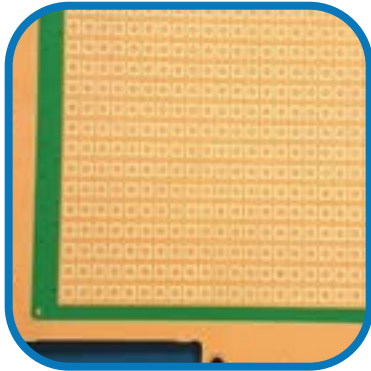

- 1G - NMT 1981, analogue technology
- 2G - GSM 1992, digital technology
- 3G - W-CDMA 2001, data transfer speed >1Mbit/s
- 4G - LTE 2009, data transfer speed >100Mbit/s
- 5G - 5G NR, currently being deployed, data transfer speed >1Gbit/s

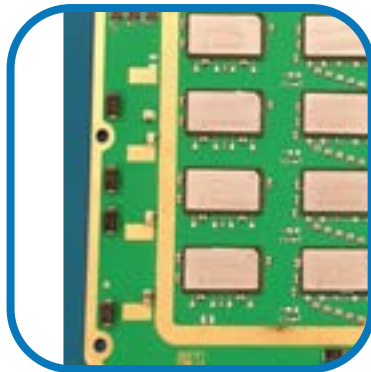

Photos: Ericsson

Henrik Sjöland, professor, active at Ericsson and the Department for Electrical and Information Technology, Lund University.

Two industry-based doctoral students from Ericsson. Associate Professor Markus Törmänen also works at Lund University on circuit design for millimetre waves, as well as a postdoc and two doctoral students.

Atila Alvandpour, professor, together with two senior researchers and two doctoral students, works on high-speed data converters at Electronic Circuits and Systems, Department of Electrical Engineering, Linköping University.

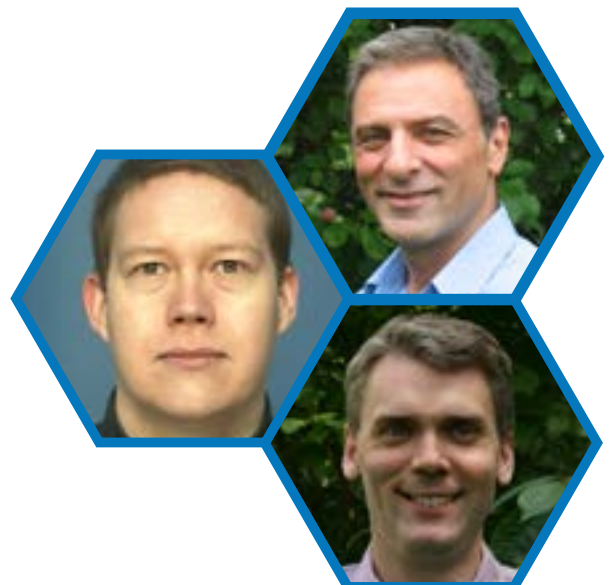



## 5G comes to vehicle communication

**For ten years, researchers in communications engineering in Lund have worked in close collaboration with Volvo Cars and other vehicle manufacturers to study communication between vehicles. The result is robust communication solutions that function in all weather conditions and in all surroundings.**

There's been an accident and rapid help is needed. If the car involved is a Volvo, it has already contacted the emergency services. If the vehicle in front slams on its brakes, the car will automatically brake to keep at a suitable distance. Everything is based on robust communication.

“Robust is a key concept here. If we have come to depend on communication technology, it must always work – with no exceptions”, says Fredrik Tufvesson, professor of radio systems in the Department of Electrical and Information Technology at Lund University.

The systems must function in all weather conditions and in all surroundings: in a snowstorm at -40 °C just as well in baking desert temperatures and a sandstorm, when the vehicle is stationary just as well as when it travels at 200 km/h.

“Communication solutions have become important when people choose a car. The system should be able to communicate with the surroundings if something happens, and it should also be able to receive and stream music and video inside the car”, says Fredrik Tufvesson.

Within ELLIIT, he has been working with his group at Lund University on vehicle communication for the past 10 years, in collaboration with Volvo Cars and other vehicle manufacturers. ELLIIT has functioned as an umbrella for collaboration within four projects that are part of the Strategic Vehicle Research and Innovation Programme (FFI) financed by Vinnova. Other actors in addition to Volvo Cars have participated in the various projects, such as Volvo Trucks, Terranet, and researchers at the School of Information Technology at Halmstad University.

“We needed in-depth understanding of how the communication between two mobile units, in this case cars, can work. The challenges that must be solved differ from those when one unit is a stationary mast. We have developed models and investigated the physical processes to find out what must be given priority in order to construct a robust system for communication between mobile units”, says Fredrik Tufvesson.



The scientists have subsequently analysed possibilities and limitations, and developed models that make it possible to test algorithms and simulate the systems in the computer, instead of building expensive prototypes and carrying out test driving.

Many of the researchers and students who have worked in the Vinnova projects are now working at Volvo Cars, and have been able to influence the development of communication solutions. Experiences from the different collaboration projects have also contributed to the design of Volvo's 5G strategy.

The research is now progressing to new objectives: the next step concerns how cars are to help each other, for example to discover an obstacle.

"If a cyclist suddenly appears in front of your car, the cars behind will be informed of this so that they can all brake at the same time", Fredrik Tufvesson explains.

Another important field of use is in vehicle convoys, where trucks drive with small separations.

"We can achieve fuel savings of 20% by driving close behind the truck in front. Even the front truck of a vehicle convoy achieves lower fuel consumption, as a consequence of the changed patterns of air eddies behind it. But it all depends on having a functioning system of signalling between the vehicles, along the complete length of the convoy."

Another example in which vehicle communication is necessary is motorway driving with two cars travelling parallel to each other at high speed. Both try to move into the same lane at the same time, which is a situation that often leads to accidents.

ELLIIT research within vehicle communication contributes in this way to higher safety, a reduced risk of accidents, lower fuel consumption, and – not least – competitive advantages for the vehicle manufacturers who participate.



The research is led by Fredrik Tufvesson, professor in radio systems in the Department of Electrical and Information Technology at Lund University. Volvo Cars and Terranet each have an industry-based doctoral student, and together with Maria Kihl's research group at Cloud Control, five senior researchers and five doctoral students are working in this area in Lund.

A further four people are based at Halmstad University, led by Alexey Vinel.



## Leaving avoidance manoeuvres to the car reduces the risk of an accident

**If you wander off the lane or touch the lane marking, your car tells you about it, and the most recent models can even gently take you back to the middle of the lane. Research in ELLIIT has shown that if the car also provides help during swift avoidance manoeuvres, the number of accidents could be reduced by around 80%.**

“Completely autonomous and driverless traffic on conventional roads and under all possible weather conditions is probably not going to be possible for a fairly long time. In particular, we must solve the problems associated with mixing autonomous and human-driver traffic during a transition period”, says Anders Robertsson, professor at the Department of Automatic Control, Lund University.

The development of autonomous aids for the driver has, however, progressed rapidly in recent years, and a technique known as “lane departure warning”, or LDW, is installed on most modern cars. The driver receives help in keeping the car in the desired lane with the aid of radar, cameras and computer power. The next step will be to aid the driver during sudden avoidance manoeuvres such as may be needed if a moose, deer or wild boar suddenly runs out into the road. The car keeps tracks of the edges of the road and can use a situation-awareness system, including visual and infrared cameras, to detect an animal on the road.

“The car also receives an indication of where the animal is relative to the car, or the direction it’s running in, and

can steer such that it misses the animal, if possible”, says Lars Nielsen, professor of Vehicular Systems at the Department of Electrical Engineering, Linköping University.

The time taken to optimise a manoeuvre to avoid a sudden moose or to take a hairpin turn in the Alps has been reduced from hours to minutes, and even to seconds, using results from the most recent ELLIIT research. Since 2010, new tools and methods for dynamic optimisation of vehicle manoeuvres have been developed in several doctoral student projects, in collaboration between Lund University and Linköping University.

“We can numerically determine which the optimal manoeuvre is and then decide which control principle is the best”, says Lars Nielsen.

One example of a control principle is to study the force vectors on the car, from tyre friction, brakes and steering. One of the results that Victor Fors presented in his thesis at Linköping University is that the safest manoeuvre is one in which the resultant force is maximised in one direction, obliquely backwards.





In this case, the force from each tyre is used and collaborates to give maximal force in the avoidance manoeuvre.

Our simulations with this method show that we get very close to the optimal avoidance manoeuvre, says Lars Nielsen.

Together with Björn Olofsson from the Department for Automatic Control at Lund University, Lars Nielsen has examined 233 run-off lane accidents recorded in a German accident database. All accidents ended in fatalities or very serious injury. The researchers examined entry speed, radius of curvature, etc., in order to determine how many accidents could have been avoided with an autonomous system. They concluded that around 80% of the accidents were avoidable.

“It’s not always possible to avoid a collision, but since the car is braking as hard as possible, we can conclude that the speed is reduced also in the other cases to such an extent that the injury degree is less”, says Lars Nielsen.

Humans can react rather too slowly, or maybe we panic and turn the steering wheel too much. It’s also possible

that a driver falls asleep in some cases and the car leaves the carriageway.

Expertise within this field of research has been disseminated to the automotive industry when doctoral students who have worked within ELLIIT projects since 2010 have graduated and continued to key positions at companies such as Scania, Volvo Trucks, Volvo Cars and Mitsubishi Electric.

The most recent results have also been spread through the courses, both at undergraduate level and for doctoral students, held at Lund University and Linköping University. Examples include the doctoral course “Motion Planning and Control” and the master’s course “Autonomous Vehicles – Planning, Control and Learning Systems”, which have become increasingly popular among students in both Lund and Linköping.

“Interest is growing. Autonomous vehicles are already being used in mines and enclosed environments such as harbours. We are, however, also looking at the forces in robot arms applicable for harvesting in forestry and in many other contexts within robotics”, says Anders Robertsson.

The research is led by professor Anders Robertsson and professor Lars Nielsen. At the beginning of 2021, four senior researchers and four doctoral students are working in this field in ELLIIT projects.

Anders Robertsson, professor, Department of Automatic Control, Lund University. Lars Nielsen, professor, Vehicular Systems, Department of Electrical Engineering, Linköping University. Björn Olofsson, Docent, Vehicular Systems, Department of Electrical Engineering, Linköping University and Department of Automatic Control, Lund University. Erik Frisk, professor Vehicular Systems, Department of Electrical Engineering, Linköping University.

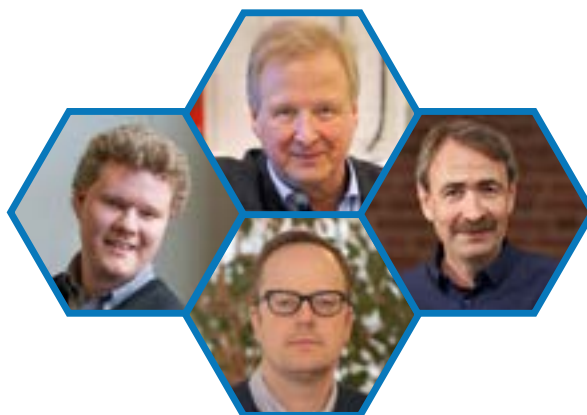

## Robots becoming part of everyday life

**Children with autism can improve their social skills with a cute and friendly robot, and older people with dementia feel calmer and more at peace with a robot cat purring on their lap. This has been shown by recent cognitive systems research, but the question remains: how do we interact with robots when social signals such as eye contact are not available?**

Robots are slowly but surely becoming part of everyday life. So far, they carry out such simple tasks as vacuuming the house or mowing the lawn, but this is just the first step. It has become clear that social robots with human- or animal-like appearance can increase people's well-being.

During the EU research project DREAM, a collaboration between six European universities that ended in 2019, Professor Tom Ziemke and his colleagues showed that social robots can be useful in therapy for children with autism. SoftBank Robotics, a company that participated in the project, is continuing to develop solutions that facilitate learning and increase the ability of children with autism to communicate with the people around them.



Tom Ziemke is professor in the Division of Human-Centred Systems, Department of Computer and Information Science, at Linköping University, where his professorship is partly financed by ELLIIT. He is now continuing the work of the DREAM project in collaboration with several homes for the elderly in Östergötland. A robot dog and a robot cat have visited care homes for older adults with dementia.

“We focussed on robot cats, but some of the elderly didn't like cats, so we had to take a dog along as well”, he says.



A nine-month study was carried out before and during the corona pandemic, with positive results. Sofia Thunberg, a doctoral student supervised by Tom Ziemke, studied how older adults interacted with the robot cat: how they talked to and about the cat – or dog. She also interviewed personnel at the centre. In the next step, she will take a user-centred perspective to investigate how robots can be introduced, used and evaluated, giving an increased quality of life for older adults and people with dementia.

During the autumn of 2018, Sofia Thunberg studied in collaboration with the Swedish national train operator SJ ethnographical aspects of how passengers interacted with a humanoid robot at Stockholm Central Station. The robot, Pepper, answered questions and helped passengers.



Other examples could be given, and some of the research deals with how we can interact with robots that do not resemble people or animals. The research group collaborates, for example, with both RISE SICS and Saab in several projects that study how people interact with swarms of drones and unmanned vessels. A planned collaboration with Toyota Material Handling addressed how warehouse personnel interact with autonomous trucks that buzz around carrying goods.

In 2021 and 2022, a postdoc financed by ELLIIT will study how people interact with the autonomous buses that traffic Campus Valla at Linköping University.

The bus, known as ELIN, currently moves at walking pace around the campus and everyone who studies or works there sees it every day. The project, which is a collaboration with the Swedish National Road and Transport Research Institute, will allow the bus to servi-

ce more distant off-campus areas and, eventually, drive at higher speeds.

“Robots used in public environments must be 100% safe, in all situations. We need to investigate how autonomous vehicles can function in everyday life. How does a cyclist, a child or an older person perceive a robot bus as it approaches them? Do they expect the bus to see them and stop, even if it is not possible to establish eye contact with a driver?” Tom Ziemke asks.

The vision for autonomous and small electrically powered buses is that they should function as resource-efficient transport for commuters. In this case, they would travel at significantly higher speeds and would thus require longer braking distances. And maybe in the future they would have a robot dog onboard to help their owner get home safely.



Tom Ziemke, professor, Human-Centered Systems, Department of Computer and Information Science, Linköping University.  
One post doc and two doctoral students.





## From a degree project to 9000 citations and a company

**Visual object tracking is a field in which Professor Michael Felsberg and his co-workers have led scientific development since 2013: their prolific scientific publications have not only been awarded several prizes, but also been cited by many other researchers. The newly established company Singulareye is based on the research results.**

Interest in visual object tracking has exploded in recent years as a consequence of increasing interest in autonomous vehicles, robotics, artificial intelligence, and machine learning.

The technology has advanced rapidly and one reason for this is something as unusual as a competition, the Visual Object Tracking (VOT) Challenge, arranged each year since 2013.

“The competition gathers the most renowned researchers within the field at leading universities throughout the world”, says Michael Felsberg, professor in computer vision at Linköping University. He has been a member of the competition organising committee for some years now.

Michael Felsberg won the prestigious competition in 2014, together with his doctoral student at the time, Martin Danelljan, Fahad Khan, a co-supervisor and researcher in the division, and Gustav Häger, at the time an undergraduate, now doctoral student. As a continuation of his degree project, Martin Danelljan had developed a method in which the computer follows an object within a defined box, known as a “bounding box”, in the image.

The computer learns the appearance of the object in the box in different conditions, both its colour and shape, with the aid of features in the image – edges or colours. The calculations are then rapidly performed using carefully chosen algorithms. The group had in their work removed an important stumbling block within object tracking: the problem of scalability – a moving object changes its apparent size and shape as it recedes from the camera.

The group published the work as open-source code, which led to thousands of citations in a very short period. The research carried out in the group is partially

financed by ELLIIT, and has subsequently been awarded several prizes. When Martin Danelljan defended his doctoral thesis in 2018, his work had already received over 2000 citations, and today the number is over 9000.

In the past two years, the research has taken a further step.

“The research is now, however, starting to increasingly use a technique known as ‘segmentation’ in which pixels in the image are classified as belonging to different objects. In classification the computer should be able to distinguish, for example, a sleeping dog from the sofa on which it is sleeping. To put it simply, segmentation means doing the same thing at pixel level”, says Michael Felsberg.

Development in the field has increasingly come to be dominated by Chinese researchers, and they won all prizes except one in the most recent edition of the VOT Challenge.

“They have large resources for research in the field, in particular for improving facial recognition. This is an accepted technology in China, but is ethically problematic in the western world.”

Other areas of application for visual object tracking are both broader and less controversial. Examples include autonomous vehicles that can discover and follow pedestrians and bicycles in traffic, flying vessels that search for people in need of help in disaster areas, and mobile phone cameras that can focus automatically on a face in the image (if any).

“In a few years we will probably have a function in all mobile phones where we can record video and switch backgrounds while recording”, says Michael Felsberg.

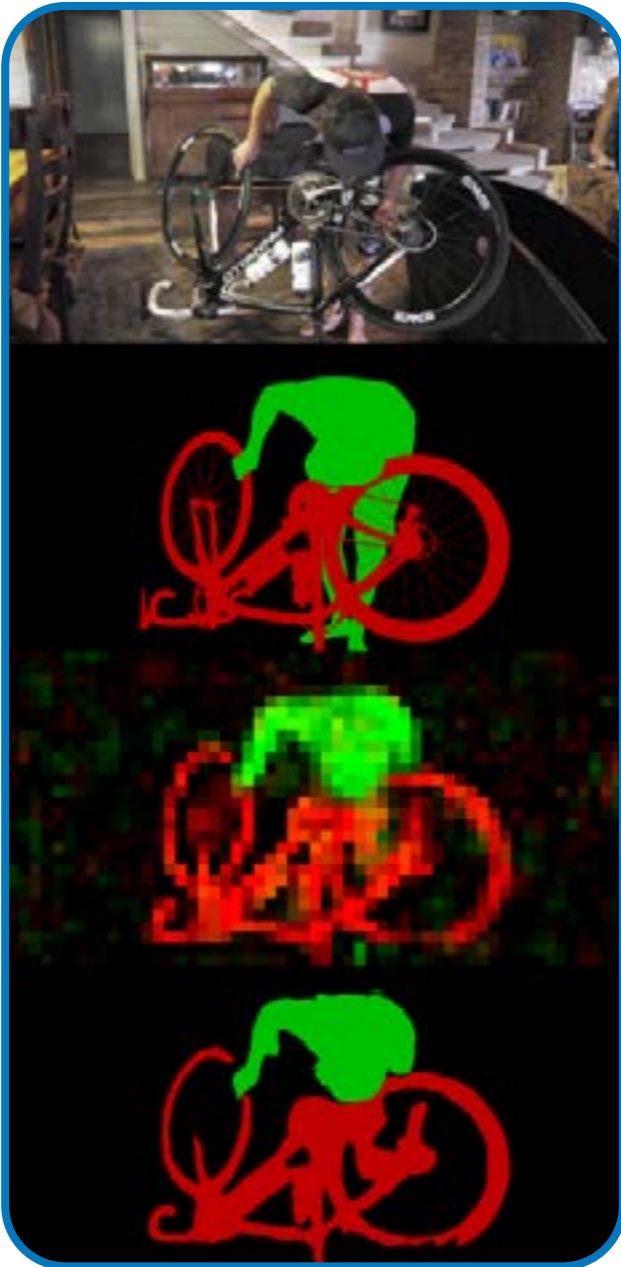

Segmentation, uppermost – a frame from the video.  
 The next image shows the ground truth.  
 The third is an intermediate stage within the deep network.  
 Finally, the result of the object segmentation.  
 Illustration: Andreas Robinson, CVL

The objectives of the research, however, are higher than that.

“We construct our world-view primarily on what we see and experience, and robots that are to function together with people must have the same ability. It must be possible for AI systems to learn from data without complete annotation, and based on only few examples (one-shot learning). We cannot expect that all the data processed by artificial intelligence will first be created by a human and then learnt by a system. We must be able to define a starting point and direction, and then leave the learning process to proceed unsupervised”, he says.

Martin Danelljan, who is today (2020) a postdoc at ETH in Zürich, founded the company Singulareye in 2018, together with two other doctoral students. In addition to world-leading knowledge in visual object tracking, the company offers consultancy services with expertise in deep learning and AI. Its largest customers are found in the automotive industry.



Michael Felsberg, professor, Fahad Khan, associate professor, Per-Erik Forssén, associate professor, Mårten Wadenbäck, assistant professor, and three doctoral students, Computer Vision Laboratory, Department of Electrical Engineering, Linköping University.

## Finding your way with three-in-one

**Now you don't have to wander round searching for an empty meeting room at the office or for a particular shop in a huge shopping mall. An app in your phone can not only find it, but also show you the way there. Three sources of information indoors replace what satellites do outdoors.**

The Senion AB company was founded in 2010 after a course in entrepreneurship at Linköping University. Its first product was an app that guides visitors in large shopping malls and helps them find their car again, if necessary.

“On the course, four of our researchers in sensor fusion happened to meet a researcher from the Department of Computer and Information Science. Our researchers could handle the technology while the information scientist managed the application”, remembers Fredrik Gustafsson, professor of sensor fusion in the Department of Electrical Engineering, Linköping University.

The first order came from 80 large shopping malls in Singapore, and the system is now in operation in places such as the largest shopping mall in America, Mall of America and the largest shopping mall in the world, Dubai Mall.



Visitors get a blue dot on the indoor map thanks to Senion's innovation, which allows the app to track them as they move through the centre, and back to the car again. The routes they take are logged anonymously, and the owner of the shopping centre can analyse the patterns, how many people take a certain pathway and how long they remain at any location. The shops can also send out special offers to customers in the shopping centre through the app.

A more important use case, however, may be the modern and smart office, where an employee can rapidly find an unoccupied workplace or meeting room. If they haven't had time to book in advance and send out an agenda, the app looks after this as the employees enter the room. As they leave the room, the app asks whether they want to end the booking.

“Large companies with flexible offices can save money directly here. The employees save time, and the company can manage with smaller premises”, says Fredrik Gustafsson.

When outdoors, we are used to navigating using maps and GPS, but this doesn't work indoors. The system instead is based on information from three completely different technologies; inertial sensors, radio signals, and building plans. In order to join such completely different sources of data, a particle filter is used.

An inertial sensor senses acceleration and speed of rotation. The system uses the sensors to find out how the user moves through the building relative to the starting point. It also uses small, cheap and highly energy-efficient transmitters, Bluetooth beacons, along the walls, where radio measurements can measure the distance to them, as reference points. Finally, the building plans are used to determine probable alternatives for how people move around, and to eliminate impossible routes, such as walking through walls or jumping between floors.

“In order to be able to combine signals from three so completely different sources as a map, radio signals from beacons, and information from inertial sensors, we need to use particle filters. This is a technology invented in 1993 that our research group has been working with since 1998”, says Fredrik Gustafsson.

Within a few years of starting, the research group started to publish articles, both theoretical and applied, that today have received thousands of citations.



To put it simply, a particle filter generates a large number of random routes on the map, and compares the hypothetical measurements that would have been obtained with the actual measurements. Each proposed route is in this way given a weight (probability) that is used to generate new alternative routes.

The research group has also been leaders in the field when it comes to determining position with the aid of radio, Bluetooth, since Ericsson joined the Vinnova-financed centre of expertise ISIS (Information Systems for Industrial Control and Supervision) in 1998. More recent applications include using drones to find missing people, and to keep track of grazing animals and rhinos on the savannah.

The inertial sensors have been at the heart of many doctoral theses. They were used at an early stage in the

Gripen fighter plane for positioning without the need for satellite data, and are now used within, for example, medical rehabilitation, elite sports, the gaming industry, and to ensure that figures – people and animals – in cartoons move as naturally as possible. The need for experts in the industry is increasing.

“When the first iPhone was launched in 2007, we immediately started a project to see how we could use the technology built into the phone, Bluetooth and inertial sensors, in new ways. Suddenly we had a consumer product with the same set of sensors as Gripen”, says Fredrik Gustafsson.

Senion AB is only one of several spin-off companies from the research group with its unique collection of expertise in three technologies that are normally studied in completely different scientific disciplines.



Photo: Martin Stenmarck



Fredrik Gustafsson, professor, Division of Automatic Control, Department of Electrical Engineering, Linköping University.  
Founders of Senion: Peter Bunus, Jonas Callmer, Christian Lundquist, Per Skoglar and David Törnqvist.

## Visualising the invisible

**The possibility of visualising huge amounts data is critical for increasing knowledge in fields such as climate science, materials science and medicine. Visualisation research has also given rise to several spin-off companies, and interactive and educational experiences for millions of children and young people.**

Visualisation research financed within ELLIIT started in earnest in 2012, when the development of Inviwo, a platform for interactive visualisation, took off at Linköping University.

“Inviwo is essentially a research platform in which we can design and evaluate visualisation methods. It’s a powerful platform, and the visualisations are efficient and interactive, which means that our results are also used in several commercial products”, says Ingrid Hotz, ELLIIT professor in scientific visualisation in the Division for Media and Information Technology (MIT) at Linköping University.

To simplify somewhat, the system consists of three layers. The lowest layer consists of building blocks used for all visualisation applications as well as communication with the underlying hardware – you could say that this is the basic ingredients of the recipe.

The intermediate layer makes it possible to experiment with new algorithms and code, while the highest level provides a user interface that makes it easy to combine different algorithms and functions in different ways, simply by drag and drop. Using the highest level doesn’t

require any programming skills. The source code of the algorithms and the platform itself is open source and free to use even for commercial purposes.

“The platform has been developed so that we can quickly evaluate new algorithms and experiment with them. An efficient interface means that we can rapidly access and change things also in the lower layer”, says Daniel Jönsson, associate senior lecturer at MIT.

The results of the research are also rapidly available to other researchers and companies.

The high quality of the visualisations and the rapid rendering have been important competitive advantages when companies working in medical visualisation, such as ContextVision and Sectra, chose the algorithms developed in the ELLIIT project for their products. Sectra, which has its origins at Linköping University, has a close collaboration with the research group working on, for example, the virtual autopsy table. The virtual autopsy table is also a result of research at LiU. It has been successfully commercialised by Sectra and is today used in medical studies and other applications all over the world.

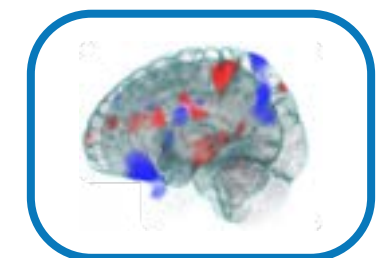
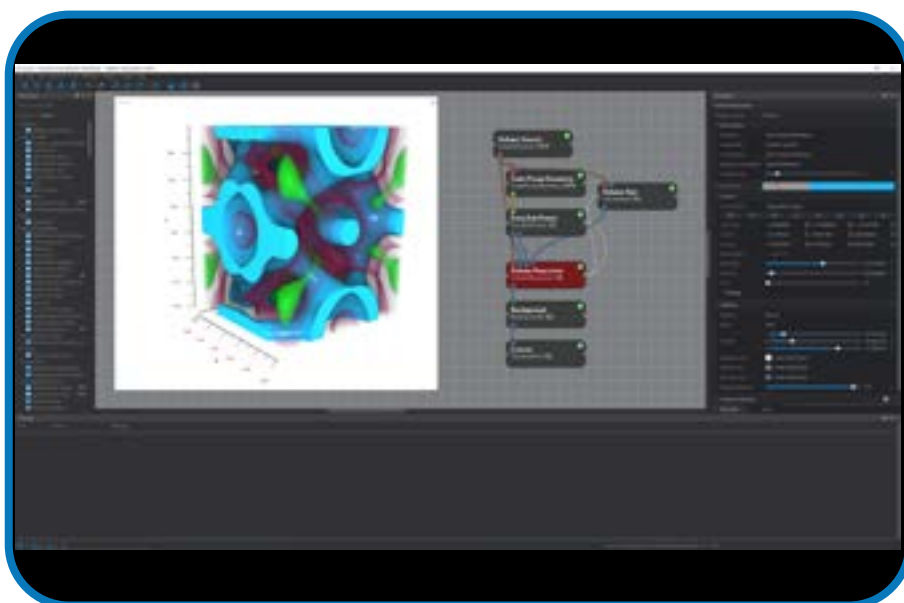

Research within visualisation has seen rapid development. The initial work within the field was concerned with, for example, finding efficient algorithms to render volume-based data, while current research is targeted more towards visualising complex correlations within various domains that are critical for society.

Examples of domains include, for example, medical visualisation, materials science and flows, biological visualisation of proteins and viruses, and visualisation within space technology and astronomy.

Inviwo is now used by researchers not just at Linköping University, but also at the Royal Institute of Technology in Stockholm, Ulm University in Germany, and the University of Bergen in Norway.

Vistinct, a spin-off company whose founders include Daniel Jönsson, has enabled Inviwo to reach even further. The platform is now also used to develop educational and exciting scientific installations at the National Museum of Science and Technology in Stockholm, and Visualization Center C in Norrköping.

“The research within ELLIIT has enabled millions of children, young people and adults to be inspired. They have been able to interact with science and technology and learn more about them. Thus, the impact of Inviwo has been hugely significant far outside the academic world”, says Anders Ynnerman, professor of scientific visualisation at Linköping University and director of Visualization Center C.

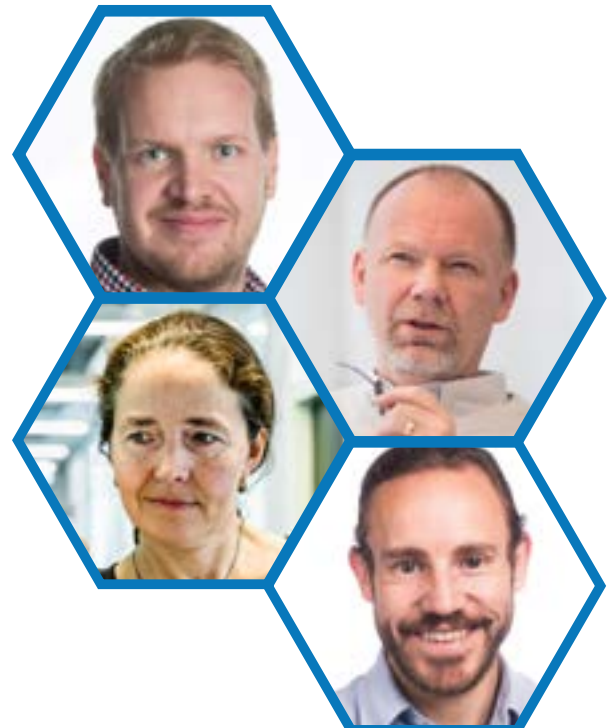
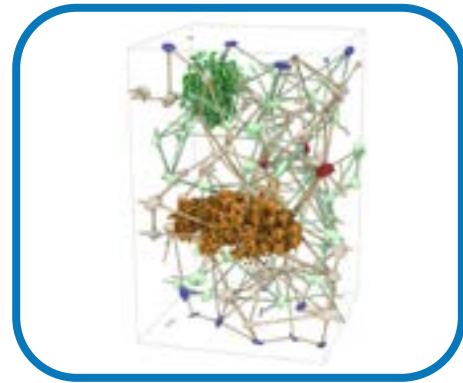
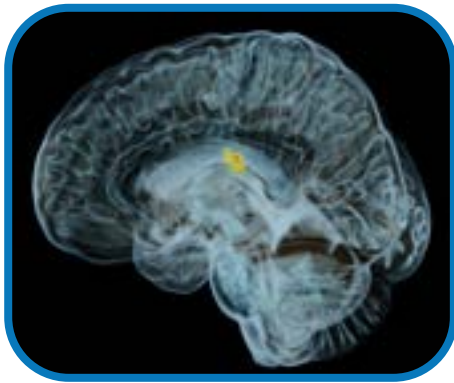

Professor Ingrid Hotz, Associate Senior Lecturer Daniel Jönsson, Principal Research Engineer Peter Steneteg, and Professor Anders Ynnerman. All of these are active at the Division for Media and Information Technology, Department of Science and Technology at Linköping University, Campus Norrköping. The number of people involved in Inviwo at LiU is currently approximately 3-4 doctoral students and 5 senior researchers, including postdocs.



## Keeping track of open-source code

**Libraries of open-source code, readily available online, are a gold mine for companies that develop software. However, their use may introduce vulnerabilities. Debricked, a company founded at Lund University, scans the internet and warns users for bugs, vulnerabilities and attacks.**

The web-based services and apps that help us with such matters as contacting the medical care services, the bank and various government agencies contain almost without exception computer code obtained from code libraries on the internet. Such code is known as “open-source code”. The code libraries contain huge amounts of code that has been tested and shown to be reliable in many different applications. It is most often maintained by groups of committed developers and users in various communities.

“The time needed for development is considerably shorter, and there’s no reason to reinvent the wheel”, says Martin Hell, senior lecturer in electrical and information technology at Lund University.

He believes that 90-99% of all software in systems, web-based services and apps contains at least some open-source code. A typical code base consists on average of 60% open-source code, i.e. code that is freely available online for anyone to license and use.

“There are millions of libraries, and many are used by companies all over the world”, he says.

But all software contains vulnerabilities and bugs, which opens the risk for hacker attacks. These are often directed to where they can do most damage – code that is used by many people and in many applications.

Attention was drawn to this risk and the dependencies that it involves some years ago in a Vinnova project led by Lund University, in which two departments, a research institute and several companies participated. The project resulted in a proof of concept showing that a functioning software solution was possible. During the project, software was developed that scans the internet looking for signs of vulnerability, to detect warnings and alarms as soon as they arise anywhere in the world.

The concept was so well received that it was commercialised in 2018 in the Debricked AB company, with support from LU Innovation. The company continues

to develop software today with around 20 employees, several of them previously doctoral students in the project. The company is supported by venture capital.

“We can scan the internet and use machine learning to rapidly raise warnings, such that companies can immediately make decisions about action”, says Martin Hell.

It is not just alarms about bugs or the discovery of malware that companies can receive information about. It’s also a case of evaluating the health of the software and the community, the group of developers that maintain the code.

“The inner core of a community often consists of committed developers who do this in their free time. If one or several of them change jobs, start a family or go on sick leave, it can quickly influence how the code is developed and maintained. It takes longer for vulnerabilities to be discovered and fixed, and for the community to add new functions and maintain compatibility with other software. The strength of the community and its general health are two of the parameters that we investigate”, says Martin Hell.

Another service that he and his colleagues focus on is helping companies to discover breaches of licensing agreements. This can be checked right down to the level of a single block of code. One application can contain thousands of code strings with different licences, and it can be expensive if the code is used in a prohibited manner. There are also large libraries in which the community requires that all other code that is used together with code from the library is also published as open-source. Many companies are not prepared to meet such a requirement and must for this reason use another library.

“Some companies have well established routines to manage open-source code and licences, but in many companies it is the developers themselves who choose which library they use”, says Martin Hell.

“We try to help companies to obtain an overall view with respect to vulnerabilities, health and licences. We are seeing a clear tendency that expertise is located further down in the organisation of companies instead of at management level, as it was before. We want to ensure that expertise and security awareness is passed to the individual developer, and that one member of every development group has principal responsibility for these issues”, he says.

Under the large ELLIIT umbrella, Martin Hell and his research colleagues provide the most recent results in this field. The software for communication in the 5G network, and eventually the 6G network, will contain considerable amounts of open-source code, as will most of the units and services that use the 5G and 6G networks, now and in the future.



Martin Hell, senior lecturer in electrical and information technology at Lund University.



## Computer tools build bridges between research disciplines

**When experts in automatic control and those in real-time solutions work independently, the result may be expensive solutions. Or even total misunderstanding. Researchers in automatic control (Lund) and embedded systems (Linköping) have worked in collaboration for many years to develop computer tools that bridge the gap.**

Nowadays, hundreds – even thousands – of computers are interconnected in networks, in embedded systems, in cars, aircraft and manufacturing industries. These dynamic systems are controlled with the aid of methods developed in automatic control. The engine, car, aeroplane or factory is caused to act as desired with the aid of feedback, in which the results from control signals are returned to the control system, which issues new control signals in an unceasing loop.

The science of real-time systems is another field that is highly relevant for embedded systems. This branch of computer science studies time-critical computer systems, in which the calculations must be performed so rapidly that control signals can be issued in real time.

These two disciplines, automatic control and real-time systems, have a common origin in the 1960s, but have developed in different directions. They have become separate fields, each with its own concepts and methods.

“Few researchers and engineers have expertise in both branches, which sometimes leads to expensive solutions and may lead to complete misunderstanding”, says Anton Cervin, senior lecturer in the Department of Automatic Control, Lund University.

For many years, however, scientists at Lund University and Linköping University have worked together to bridge the gap between the two disciplines.

“A doctoral student working with Professor Petru Eles and Professor Zebo Peng at LiU contacted me. He was working with real-time systems and was interested in automatic control. So we set up collaboration, and when the ELLIIT programme eventually started, we already had projects under way”, says Anton Cervin.

The collaboration within ELLIIT has led to several computer tools that bridge the two scientific fields. These

tools have been welcomed with open arms by industry. The most widely used is TrueTime, a simulation tool available free of charge and based on the standard software in the field, Matlab.

“TrueTime is an engineering tool for rapid prototyping in which all or parts of a system can be built and simulated in the computer before a physical prototype is built. ABB has used TrueTime to simulate a new wireless communication protocol for industrial automation, just to take one example”, says Anton Cervin.

The researchers initially kept track of how many people downloaded the tool.

“We’ve stopped doing that, but we know that we have thousands of users in academia and industry all over the world.”

Several tools – Jitterbug, JitterMargin and JitterTime – have been developed for research purposes. These carry out deep theoretical analyses of system reliability, robustness and performance.

“Our current research is a collaboration with General Motors, using Jitterbug and JitterMargin for the co-design of communication and control systems in a new vehicle”, says Anton Cervin.

The tools are particularly significant when the developers need to determine how powerful, and thus how expensive, the required components are.

“The tools give information about how different subsystems that share common resources can collaborate without disturbing each other. Such bottlenecks are difficult to discover when automatic control specialists and real-time specialists work independently. We provide a common language that everyone agrees on, giving an overall understanding of the complete project”, says Anton Cervin.



# Networked embedded applications

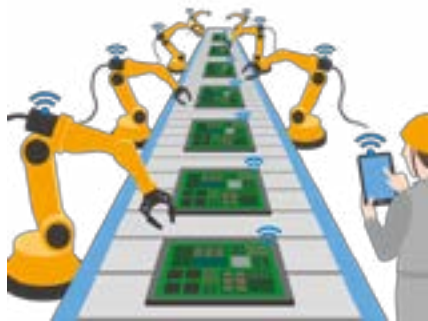

Five senior researchers and two doctoral students are working in the field.

Anton Cervin, senior lecturer, Martina Maggio, senior lecturer, and Karl-Erik Årzén, professor, all from the Department of Automatic Control, Lund University, and Professor Petru Eles and Professor Zebo Peng, from the Department of Computer and Information Science, Linköping University.

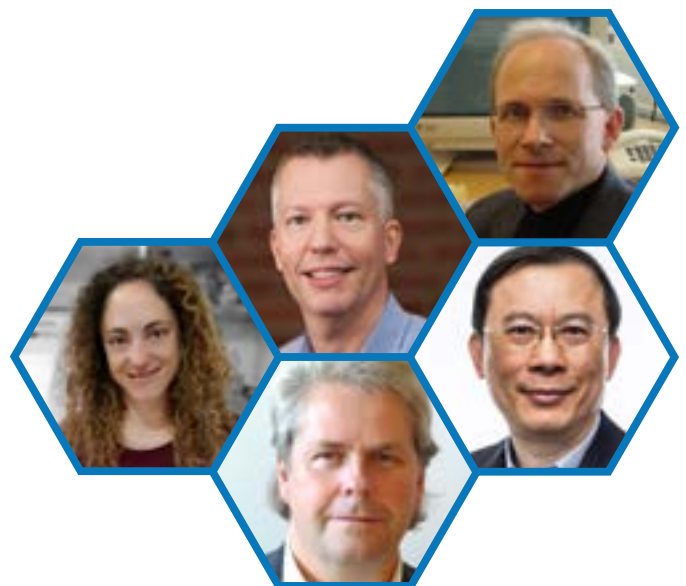

## The art of simulating and optimising cyber-physical systems

**Remember these words: Modelica, OpenModelica, Optimica and JastAdd. Ten years of collaboration within ELLIIT between researchers in Lund and Linköping, and between academia and industry, have made it considerably easier to simulate and optimise complete cyber-physical systems.**

Cyber-physical systems are embedded systems that are used in the physical world: cars, aircraft, telecommunication equipment, robots, manufacturing equipment, equipment used in medical care, and various consumer products. All cyber-physical systems consist of a complex mixture of, for example, mechanical components, electronic circuits, software and hardware.

Researchers Görel Hedin and Johan Åkesson from Lund University and Peter Fritzson from Linköping University have collaborated within ELLIIT since 2010. They have worked in several research and development projects for simulation and optimisation using Modelica, an object-oriented language created at the end of the 1990s.

Professor Peter Fritzson from the Department of Computer and Information Science at Linköping University, working with colleagues, wrote the first formal specification for Modelica, and in 1998 founded a company, MathCore AB, to provide implementations based on Modelica. In 2002, he took the initiative to OpenModelica, an open-source implementation that researchers and industry can download and use free of charge. In order to support the development of the tool in the long term, he also took the initiative to forming the Open Source Modelica Consortium, a non-profit society that now has more than 50 member organisations from both the academic world and industry.

The Modelon company was founded in Lund in 2005, as a spin-off from the Department of Automatic Control. Its business idea was to develop libraries for Modelica, and it found its customers mainly within the automotive industry.

Görel Hedin, professor of software technology in the Department of Computer Science and her group developed new techniques that made it simple to create a compiler that translates code in a high-level language

to a low-level language, such as machine code. The researchers incorporated the techniques into JastAdd, an open-source tool that they also used to develop a Java compiler.

“The tool is used to describe the desired tasks of the compiler at a high level, using equations, and the compiler is then generated from the description. We chose Java, but the technology is generally applicable and works for other complex languages such as Modelica”, says Görel Hedin.

Johan Åkesson was at the time a doctoral student in automatic control at Lund University, and found the tool highly useful in his thesis work. He used JastAdd to extend Modelica with support for optimisation, and in this way created Optimica. Previously, the software had been able to simulate, for example, a car driving around a track: now it could also optimise the car’s speed and the path chosen through a curve.

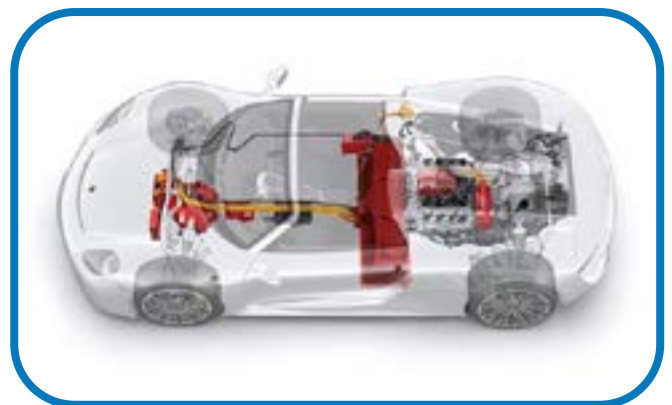

Illustration Porsche

Johan Åkesson moved to work full-time at Modelon in 2013 with the Optimica Compiler Toolkit simulation software package, which is now an integral part of Modelon’s range.

“We will continue our long-term collaboration with Modelon”, Görel Hedin confirms.

A further step was taken a few years ago when the groups involved with Modelon in Lund and OpenModelica in Linköping joined other European partners to collaborate in the development of FMI, which is today a prize-winning standard in enabling different tools to work together. FMI has also been adapted for industrial use.

“FMI makes it possible to simulate one part of the system in Modelica and another part in another simulation package”, Görel Hedin explains.

OpenModelica and the Optimica Compiler Toolkit are today well-established products that are widely used in both academia and industry. OpenModelica is used in many commercial products all around the world by, for example, ABB and Bosch-Rexroth. MathCore has changed its name to Wolfram Mathcore. It now has around 20 employees and is part of the Wolfram Group.

The Optimica software has enabled Modelon to grow in recent years from 15 to 80 employees. In 2020, the company launched a cloud-based platform, Modelon

Impact, for simulation and optimisation, which makes it possible to carry out large-scale parallel computations in the cloud.

Work with JastAdd continues in the research group at Lund University, and the software is also used by researchers all over the world. It is used by, for example, ABB to develop compilers for control systems.

“This shows the huge value of a long-term and close collaboration between the academic world and industry, in which we gain new research questions from industry and our research contributes to industrial development”, says Görel Hedin.

The Modelica programming language has its roots in the 1970s, when Hilding Elmqvist submitted a doctoral thesis in automatic control at Lund University. He there developed his ideas for an object-oriented programming language in which fundamental technical and physical correlations would be included as pre-programmed modules, or objects, in a library. The thesis was considered to be interesting, but too visionary, and remained on the shelf for many years.

Görel Hedin, professor of software technology in the Department of Computer Science, Lund University, leads the work with JastAdd, in collaboration with several junior researchers and doctoral students. Peter Fritzson, now professor emeritus from the Department of Computer and Information Science at Linköping University, works together with Docent Adrian Pop, Docent Lena Buffoni, and several junior researchers and doctoral students. Johan Åkesson is docent in the Department of Automatic Control, Lund University and CTO at Modelon.





## Smart chip design for streaming data

**ELLIIT researchers at Lund University are developing a toolbox to simulate integrated circuits, or chips, before they are manufactured. A chip consists of a large number of heterogeneous components that must all function together. Complexity is increasing, and even a slight mistake may have serious consequences for a company.**

We take it for granted today that we can receive and use streamed data. It's obvious that a camera can record both text and images, sometimes even moving images. We are happy to switch background on a digital collaboration platform while we are seen in the foreground, and with sound transfer in real time.

Behind the scenes are skilled and experienced designers of integrated circuits, or chips, which make it work, every time, without fail.

“All major companies are now working with data streams, and it's a fundamental problem here that all systems consist of a complex and heterogeneous mixture of components that process different parts of

the signals”, says Jörn Janneck, senior lecturer in the Department of Computer Science at Lund University.

He uses the camera as an example: one part of the chip receives the signal and processes it, another part looks for patterns (many cameras, for example, can zoom in to a face), while other parts carry out image processing and machine learning. The different parts of the chip have well-defined tasks.

“If a product is to be competitive, it must be small and consume as little power as possible. This means that the complexity of the heterogeneous collection of components is continuously increasing”, Jörn Janneck explains.



Chips must also be sufficiently fast, with some of the processing being carried out in hardware and some in software. The locations of components must be decided early during the design process, together with how they are to work together.

“This is becoming increasingly complicated as more functions are added. Today the performance of a chip can’t be evaluated or analysed until a late stage of the process”, he says.

This is where Jörn Janneck and his colleagues at ELLIIT come into the picture: in collaboration with the electronics industry they are building a toolbox that can simulate chip function.

A first step was taken in 2016 in a project that was part of Eurostars, financed by Vinnova. This project was a collaboration with hardware manufacturer Magillem, software developer Softeam, and École Polytechnique Fédérale de Lausanne (EPFL) in Switzerland. The Swedish part of the project resulted in a compiler suite named Tjcho, which enabled a comprehensive view of both hardware and software development.

“We have continued this work and developed a tool that can contribute to the design of many different types of system. It can analyse and characterise each algorithm on a chip. We then build a model in which it is possible to simulate several variants, and obtain feedback about what functions and what doesn’t”, says Jörn Janneck.

Decisions can be made earlier in the design process and several versions can be tested without having to build the chip.

“Companies that manufacture their own chips have skilled professionals who have been designing integrated circuits for many years. But today they are compelled to make qualified guesses about what will work, and then they add a safety margin to this. Despite this, however, expensive mistakes are sometimes made.”

Such an error in the design of a chip is not only expensive: it also delays the market introduction of new functions and products, which are extremely important for both large and small companies working with streaming data.

Jörn Janneck, senior lecturer at Department of Computer Science, Lund University, together with three post doc and two doctoral students.



## Dialogue improves software development

**Improvements in software development can benefit both companies and users. ELLIIT researchers in Lund and Karlskrona are working closely with companies, giving not only industrial benefit but also the opportunity to carry out software research at a high international level.**

Our modern society depends critically on many software systems – who can forget the anxiety associated with the millennium bug? Software must be robust and of high quality for a well-functioning society, and it must be maintained, improved and refined as knowledge increases and society develops.

Research is being conducted within ELLIIT into the management, development, maintenance and improvement of various software systems in very close collaboration with software developers in companies.

“Our research collaboration started in telecommunications, but now software is all-pervasive, in cars and other vehicles, and as special products, such as at Spotify. One of my doctoral students is working with the public transport operator Skånetrafiken. If there’s something wrong with the software the effects are immediate, with queues forming at the stations”, says Per Runeson, professor of software engineering in the Department of Computer Science, Lund University.

What the ELLIIT researchers at Lund University and Blekinge Institute of Technology contribute are improved working methods and flow in the processes. They work with a model for continuous improvement, with concepts taken from manufacturing industry.

“It’s often related to internal processes for the way in which software is developed and maintained. There are no standard procedures that companies use: everyone has their own. The companies bring their problems or challenges and we identify the critical elements in these. We then propose solutions in a close dialogue with the company’s developers, using a well-proven process”, says Per Runeson.

Claes Wohlin, professor in the Department of Software Engineering at Blekinge Institute of Technology, confirms that everything depends on unceasing dialogue. “We work with large and complex software systems, and

we usually improve only a small part of the process, taking small steps that fit into the whole picture. We also try to identify areas in which long-term improvement is needed. The work of our doctoral students requires a long-term perspective, and companies don’t always work in this way. So we need to deliver partial solutions”, he points out.

Working so closely with the software development departments in companies depends on solid and long-term relationships, not only with the managers who can allocate resources but also with the committed employees who are working in the project under study. “We regard these as ‘champions’, and they must also understand that we’re in a long-term relationship. It’s about skills development and ensuring that the required skills are available in the long term”, says Claes Wohlin.



A typical research project can study flows in a process. Ericsson, an important collaboration partner, may identify needs in the market, such as a function where it’s important to be first on the market. The process is conducted through several steps, from design and development, to testing and deployment. By studying each step individually, the researchers gain an impression of where the development gets stuck or slows down, and can suggest how to shorten time to market.

“We study the process and identify bottlenecks. Here, we use good old-fashioned queueing theory to get the flow going. It may be that it’s necessary to reallocate personnel or other resources”, says Claes Wohlin.



They also introduce ideas of how changes in the processes create value, for both the user and the company. Ericsson has, for example, introduced a tool to study value stream mapping (VSM) into its normal global development process, as a consequence of the collaboration within ELLIIT.

“It’s all about giving priority to development that gives the largest value to both the user and the company, in a slightly longer term. Visualising values and encouraging the companies to use value-based thinking in software development are two important parts of our operations”, says Per Runeson.

The researchers at Blekinge Institute of Technology in Karlskrona are currently working with around 30 companies, both large and small.

“It’s often large companies such as Ericsson, Sony and Axis, but we are happy to undertake projects with smaller companies that have similar challenges. By collaborating with us, the companies also collaborate with each other”, says Claes Wohlin.



Web-based tool for visualisation in a collaboration project with Ericsson. The project analyses: 1) various activities in software development, 2) which tasks are waiting to be carried out, labelled with colours (red – delayed, yellow – risk of delay, green – on schedule), and 3) possibilities to select which parts of the product or project will be analysed.

Senior lecturer and docent Nauman bin Ali, Professor Claes Wohlin, Professor Jürgen Börstler and Professor Kai Petersen, Department of Software Engineering, Blekinge Institute of Technology.  
Professor Per Runeson and Senior lecturer Emelie Engström, Software Engineering, Department of Computer Science, Lund University.  
At the beginning of 2021, three doctoral students and two postdocs were also working in the field.

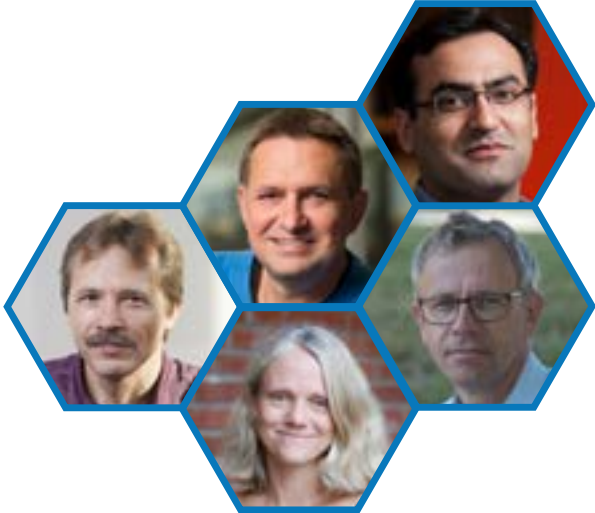

## Smart automatic control helps protons hit the target

**The success of a project is often in the details. The European Spallation Source (ESS) in Lund is a huge construction project costing billions of Swedish crowns. ELLIIT researchers' expertise in automatic control and microwave technology has played a key role.**

“We have contributed a small but technically very tricky part here, concerned with ensuring that the proton beam is accelerated in the right way”, says Bo Bernhardsson, ELLIIT professor in automatic control at Lund University.

ESS is a European research facility under construction in Lund, with a planned inauguration for research into materials science in 2023. Spallation is the process in which the atomic nuclei of heavy metals are bombarded with protons travelling close to the speed of light. Neutrons are released and caused to penetrate the sample under investigation. When the neutrons emerge on the other side, they carry information about the sample properties. Using neutrons allows scientists to see other properties than when using X-ray technology and the synchrotron radiation produced in, for example, the neighbouring MAX IV facility.

To accelerate the protons to a sufficiently high speed, they are passed through a 500-metre tunnel with 155 units, each of which supplies energy through powerful oscillating electromagnetic fields.

“The electromagnetic fields must be accurately controlled such that exactly the right amount of energy is supplied at the right instant. This is achieved by a control system that makes sure that the amplitudes and phases of the radio waves are always correct”, says Bo Bernhardsson.

He likens the process to a row of football players who pass the ball forwards at ever-increasing speed: if one of them misses timing the ball by as little as a millisecond, it will lose speed and shoot off at an angle instead of straight ahead.

“If the control in ESS is off kilter and gives the protons the wrong speed, they may impinge on neighbouring equipment. The equipment can become radioactive and

may in the worst cases break. The facility then might have to be closed down until the radioactivity has decayed and the equipment can be changed or repaired”, Bo Bernhardsson explains.

The collaboration between ESS and the ELLIIT researchers in Lund has been led by Anders J Johansson, associate professor in the Department of Electrical and Information Technology, Lund University.

The scientists have developed prototypes for the units that control the accelerator and have designed the control system in a ground-breaking digital system, constructed using a standard known as “flexible micro-TCA technology”.



Photo: Perry Nordeng/ESS

“For many years, this type of facility has been designed to use analogue technology. Since the proton beam is moving close to the speed of light, digital technology was thought to be too slow. But the microTCA system is now being introduced at several facilities in the world: this has been a wise choice in which Anders J Johansson was one of the driving forces”, says Bo Bernhardsson.

In this context, the researchers have had great benefit from previous collaboration with Ericsson in milliwatt radio technology.

“Similar technical problems arise for megawatts. The technical expertise in mobile telephony available in Lund has been a great help”, Bo Bernhardsson concludes.

The algorithms used in the control system that is now to control the proton beams were developed in collaboration between ESS and the research group at Lund University. The work has resulted in a doctoral thesis by Olof Troeng with the title: “Cavity Field Control for Linear Particle Accelerators”, Lund University, 2019. Supervisors have been Bo Bernhardsson, Anders J Johansson and Rolf Johansson.

In addition to the control system, the ELLIIT researchers have also designed a system to look after the temperature control of the phase reference system that ensures that all the equipment works at precisely the right rate. It consists of a 500-metre copper tube used as a wave guide. The accelerator will have a power of 5 MW when completed and will generate a lot of waste heat. This means that the tube may expand a few millimetres if the temperature rises, giving undesired problems with synchronisation.

“The temperature variation must be kept under a tenth of a degree, and to solve this we keep the tube slightly warmer than the tunnel, using an electric coil. We can in

this way keep the tube at exactly the same temperature all the time”, says Bo Bernhardsson

The researchers made their proposals in a report, giving details of what is possible and how much it would cost. The proposals were positively received, and the solution is now implemented.

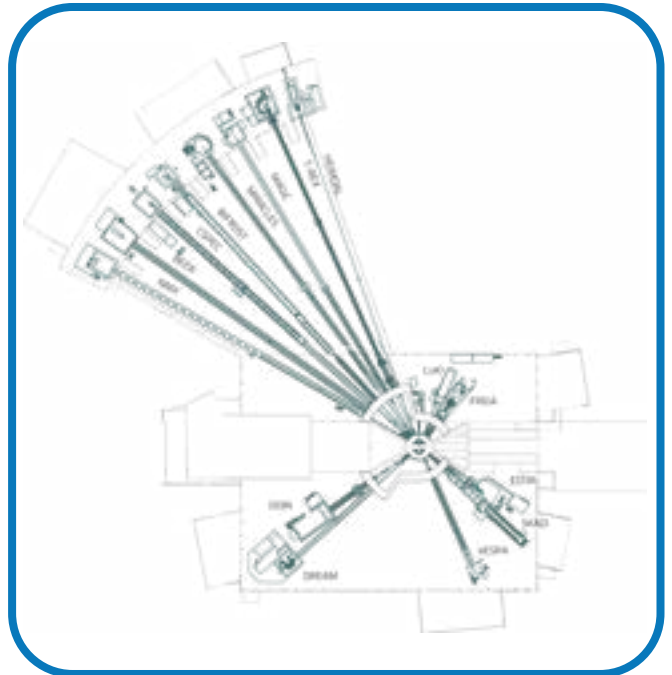

Illustration: ESS instrument layout



Bo Bernhardsson, professor, Division for Automatic Control. Anders J Johansson, docent, Department of Electrical and Information Technology. Rolf Johansson, professor, Division for Automatic Control. Olof Troeng, doctor, Division for Automatic Control all of them at Lund University.



## Degree projects bring smart agriculture advances

**A farmer can use sensors and wireless transfer to see which areas of the fields need to be watered and how much. ELLIIT Professor Björn Landfeldt and his colleague Emma Fitzgerald are supervising degree projects in collaboration with two companies, Sensative and Sensefarm.**

Sensative, based in Lund, develops technology for smart cities in which small energy-efficient sensors are linked over the internet of things to give information about energy consumption, traffic congestion, the quickest route home, etc. One of the company founders, Anders Hedberg, realised that the technology could also be used to benefit agriculture, and started a sister company, Sensefarm.

“We have collaborated with Sensative, Anders Hedberg and his colleagues, right from the start – both in regional projects here in Skåne and in EU projects. And in recent years we have also collaborated with Sensefarm”, says Björn Landfeldt, professor in network architecture at Lund University, whose post is partly under the auspices of ELLIIT.

LoRa, a standard protocol for radio communication over long distances, is used for wireless transfer. It is necessary to use long-range signals in the countryside, where the fields are large and base stations are separated by considerable distances. Further, LoRa has a low energy consumption, which is important where it is too expensive to lay electrical cables, and thus batteries or solar cells must be used as sources of energy. It is, however, difficult to achieve sufficient coverage. A large barn, storage silo or a hill can be sufficient to create a radio shadow, and weaken or completely block the signal.

“In two degree projects in network technology, we have looked at different ways to solve this”, says Björn Landfeldt.



Photo: Björn Landfeldt



The first was carried out by Eva Jurado, who developed an optimisation tool, a mathematical model, showing how base stations should be located to achieve as high a degree of coverage as possible.

“She also tested the model in Lund, an urban environment. Since there were already base stations here, she was able to verify the model. She worked in collaboration with Sensefarm, and Anders Hedberg attended the presentation where he demonstrated an implementation that minimises cost for farmers”, says Björn Landfeldt.

In the other degree project, supervised by Senior Lecturer Emma Fitzgerald, Daniel Lundell built up a mesh network. Instead of using buried electrical cables and deploying several base stations, coverage for the region uses several radio modules, or nodes. The modules use wireless to communicate with each other, and information from the sensors can be transmitted over the mesh

network to the node that is connected to the internet at that moment.

“This technology has many advantages: it doesn’t need buried fibres or cables, and the nodes can be distributed over large regions”, says Björn Landfeldt.

One clear and immediate application for the farmer uses moisture sensors at selected locations in the fields to determine where water is needed and how much. The information is passed through the internet directly to the farmer’s computer or mobile phone. The advantages are not only better use of water resources but also crops with high quality.

Thus research and degree projects in network technology, wireless systems, and the internet of things are making important contributions to the smart agriculture of the future.

**Björn Landfeldt, professor in the Networks and Security group at the Department of Electrical and Information Technology, Lund University.**

**Emma Fitzgerald, senior lecturer in the Networks and Security group at the Department of Electrical and Information Technology, Lund University.**





LUND  
UNIVERSITY

